



GUANG YA

GX90B Series Aluminum Sliding Window

GX90B Series Aluminum Sliding Window

Product: GX90B Series aluminum sliding window
 Profile type: Ordinary aluminum section
 Frame width: 90.6mm
 Glazing option: 7~12.8mm
 Opening style: Sliding opened
 Profile thickness: 1.4mm(1.2mm)
 Consumption of aluminum profile: 6.334kg/m²

Product performance (in accordance with GB/T 8478 - 2008)

1. Wind loading resistance: Grade 8 - $4500 \leq P_3 < 500P_a$
2. Air tightness: Grade 5 - $2.0 \geq q_1 > 1.5m^3 / (m.h)$
3. Water proof: Grade 3 - $250 \leq \Delta p < 350P_a$

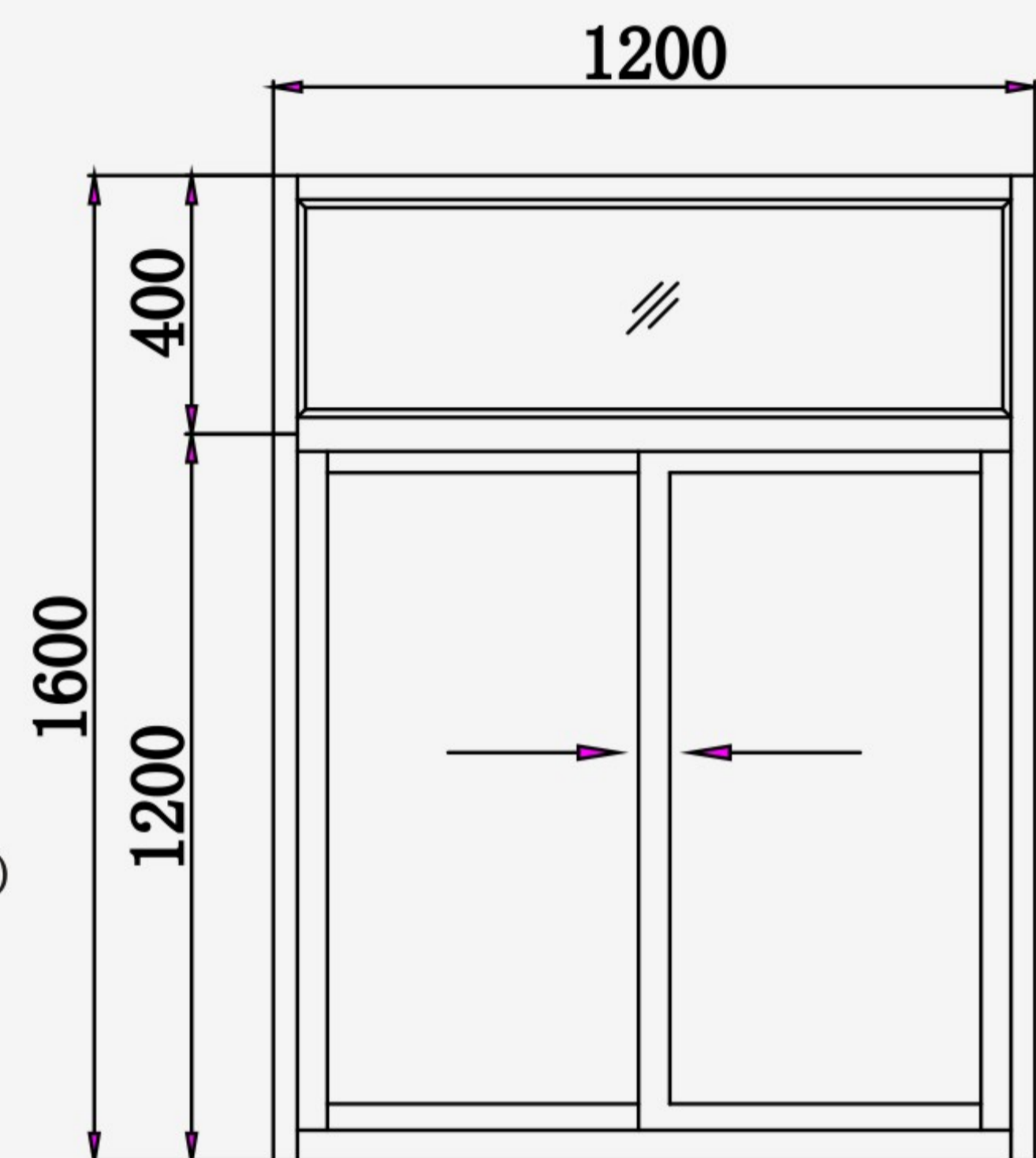

Product features:

- 1.The sliding window adopts siliconized top to seal, which make the whole window has high air leakage.
- 2.Slippery equipped with anti-theft, anti-climbing and anti-collision devices, safe and reliable.
- 3.Slide adopts trapezoidal design, with excellent watertight performance; it's durable and easy to slide.
- 4.Up and down equidistant design, both inside and outside can be installed screen, suitable for different requirements.
- 5.Fashionable, can customized different opening modes.
- 6.Strong universality of accessories, can choose crescent lock, automatic lock and bar lock by customer's reference.
- 7.Adopts 90° screw to splice, make the assembly more convenient.

Accessories provided by KinLong:

Item	Price *
TLS18K Sliding Lock (Assembled For TLS18K-10 Lock Hook)	¥ 9.55/ pc
TLK-11A Lock Block	¥ 1.25/ pc
CL50G27K14 Pulley	¥ 3.16/ pc
FDK Security Block (Black)	¥ 0.84/ pc

* For reference only,subject to further change.



GUANG YA

GX90B Series Aluminum Sliding Window

GX90B Series Aluminum Sliding Window

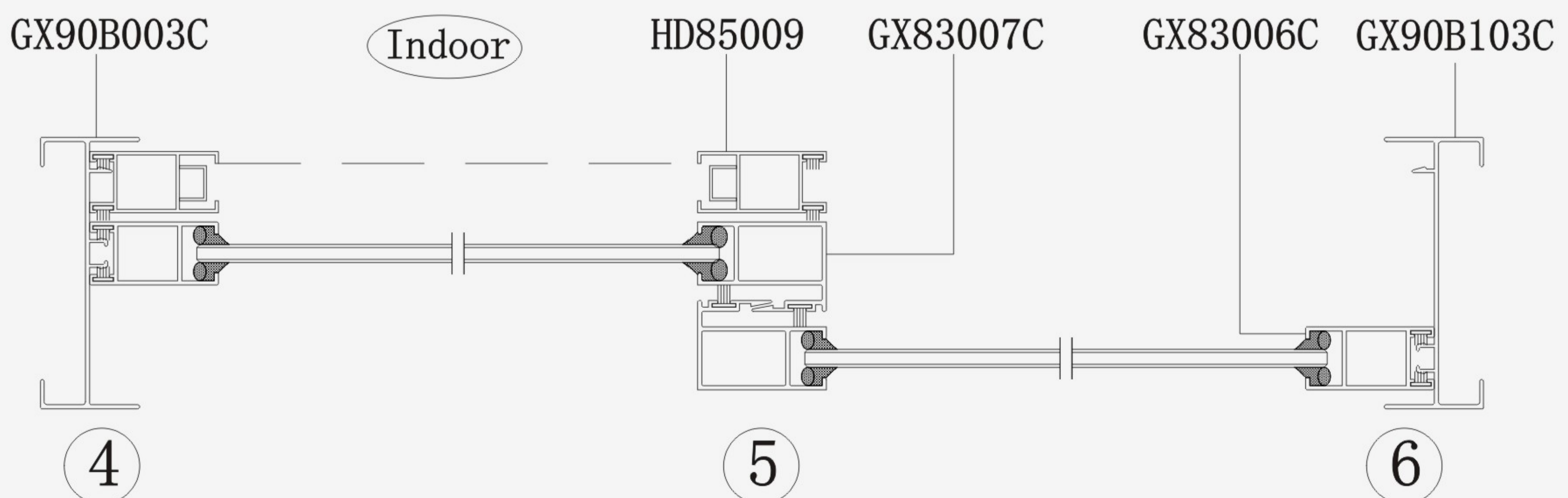
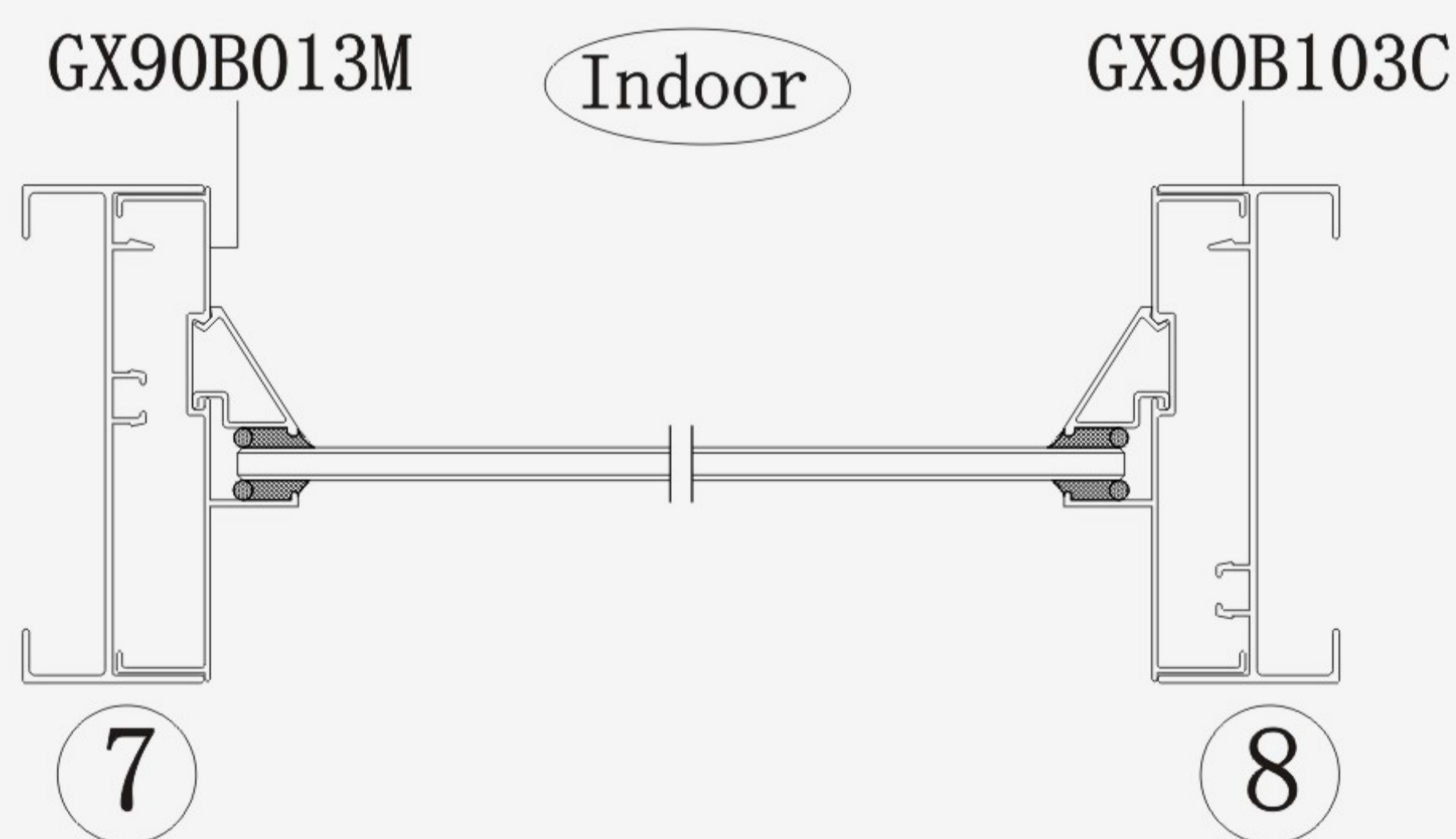
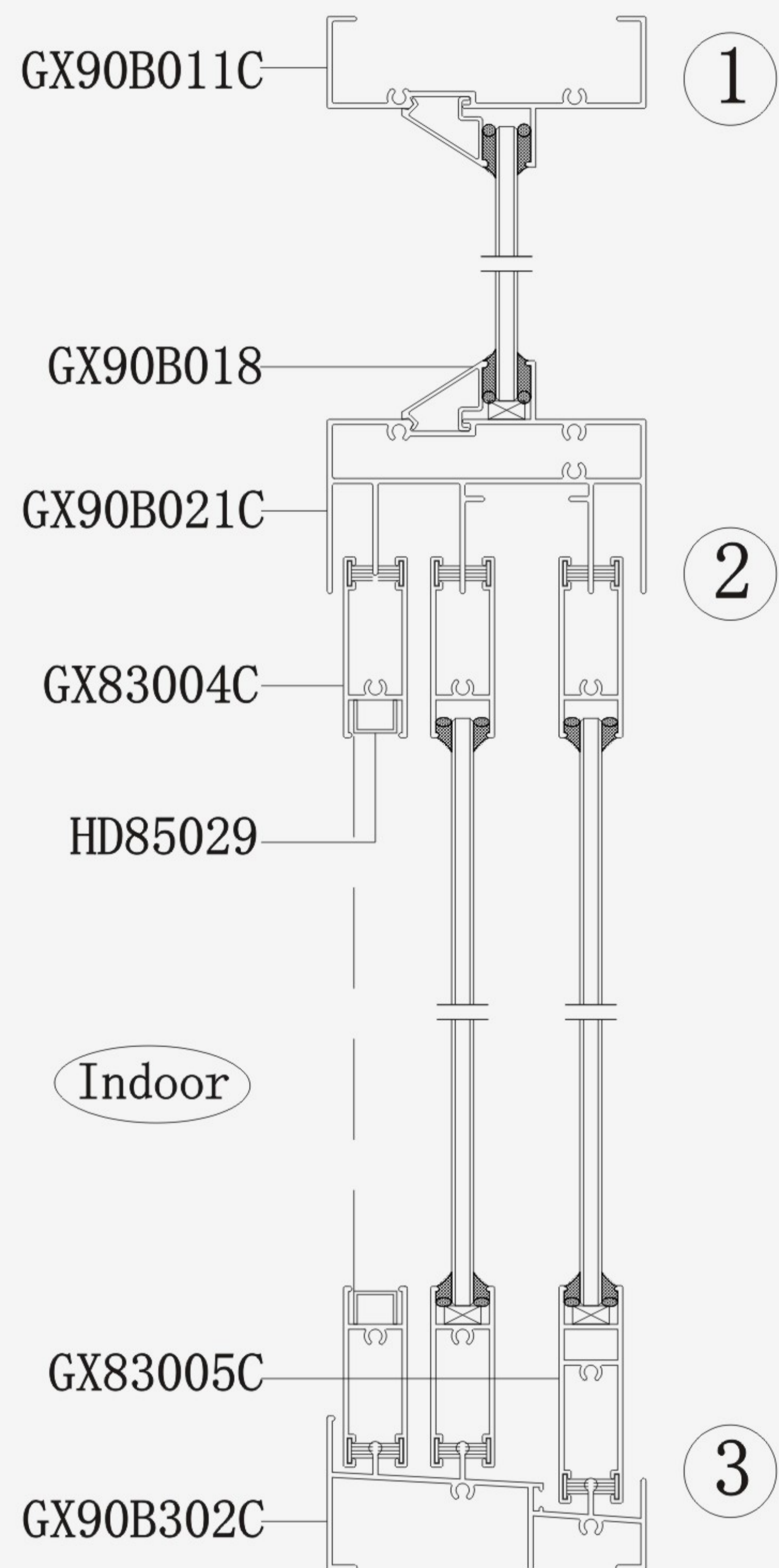
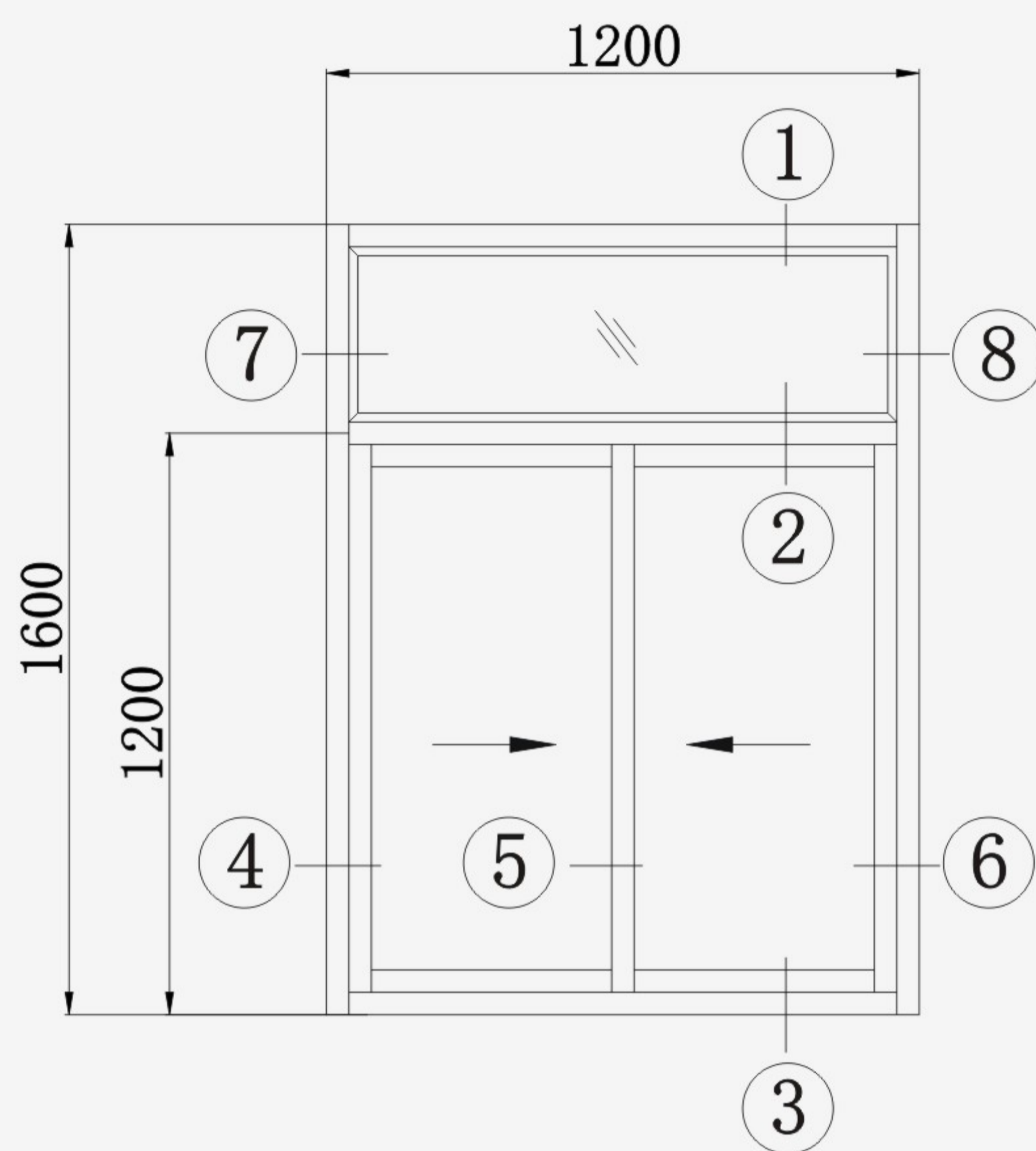



GUANG YA

GX90B Series Aluminum Sliding Window

Application	Fixed Head	Application	Single Bottom/Top Rail	Application	Sill
DWG No.	GX90B021C	DWG No.	GX83004C	DWG No.	GX90B302C
Thickness	$\delta = 1.4$	Thickness	$\delta = 1.4$	Thickness	$\delta = 1.4$
T.W.	1.550kg/m	T.W.	0.483kg/m	T.W.	0.939kg/m
Application	Single Out-bottom Rail	Application	Jamb	Application	Single Stile
DWG No.	GX83005C	DWG No.	GX90B003C	DWG No.	GX83007C
Thickness	$\delta = 1.4$	Thickness	$\delta = 1.4$	Thickness	$\delta = 1.4$
T.W.	0.614kg/m	T.W.	0.708kg/m	T.W.	0.627kg/m
Application	Jamb	Application	Single Interlock	Application	Fixed Frame
DWG No.	GX90B003C	DWG No.	GX83007C	DWG No.	GX90B011C
Thickness	$\delta = 1.4$	Thickness	$\delta = 1.4$	Thickness	$\delta = 1.4$
T.W.	0.708kg/m	T.W.	0.627kg/m	T.W.	0.699kg/m



GUANG YA

GX90B Series Aluminum Sliding Window

Application	Screens
DWG No.	HD85009
Thickness	$\delta = 1.1$
T.W.	0.403kg/m

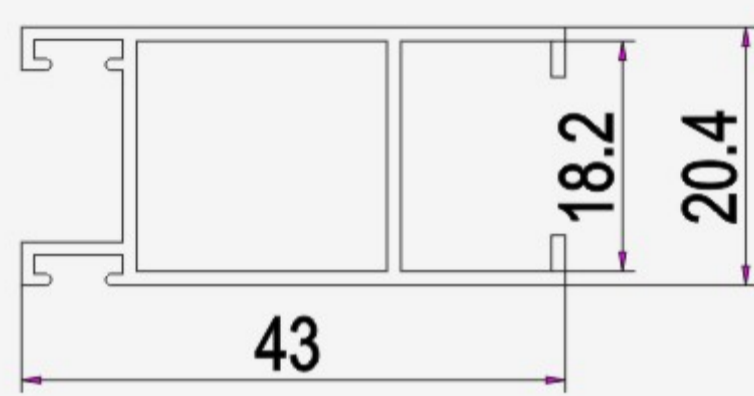

Application	Jamb Insert Plate
DWG No.	GX90B013M
Thickness	$\delta = 1.0$
T.W.	0.431kg/m

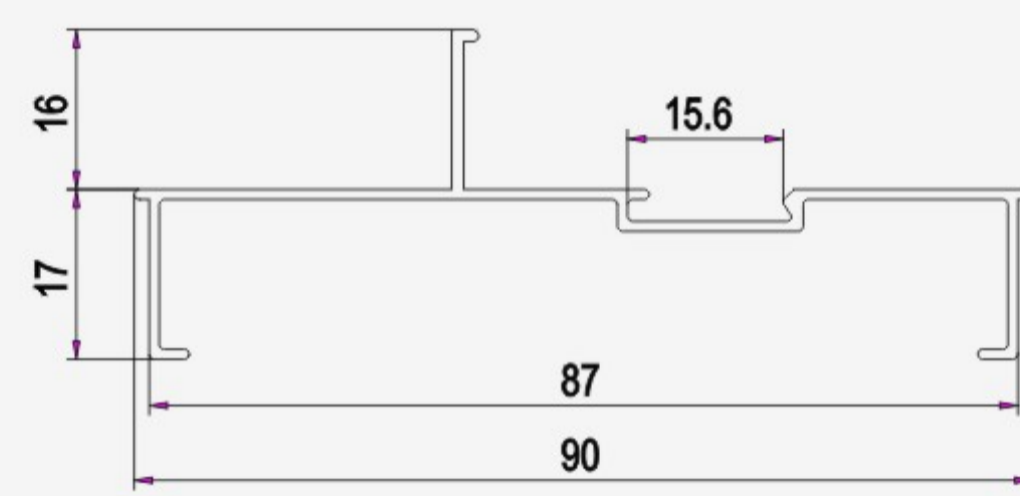

Application	Bead
DWG No.	GX90B018
Thickness	$\delta = 1.0$
T.W.	0.165kg/m

* Assembled For GX90B011C, 012C, 013M, 021C, Glazed For 10.1mm.

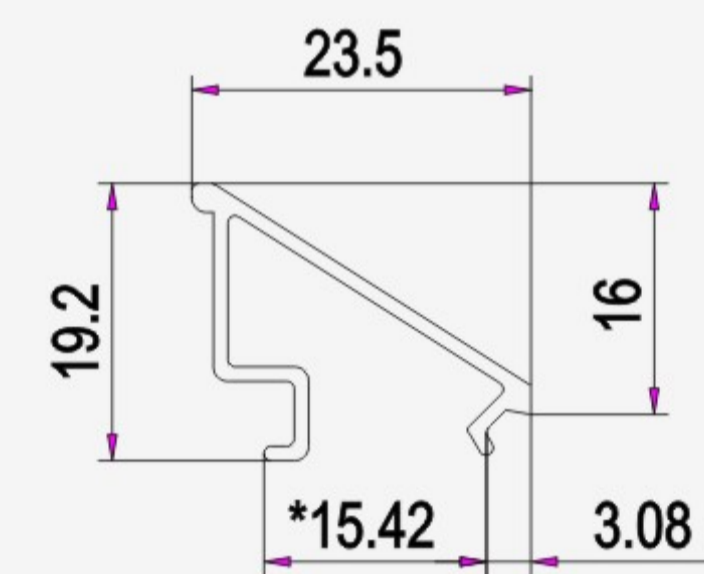

Application	U Groove
DWG No.	HD85029
Thickness	$\delta = 0.9$
T.W.	0.068kg/m

